

EAZYPODAUTO090922MAN

UK
English

EPA Est. No. 100154-GBR-1

EVOLUTION
AQUA
INNOVATION IN WATER

eazypodTM

AUTOMATIC

INSTALLATION AND INSTRUCTION MANUAL

IMPORTANT PLEASE READ:

When you first start up the EazyPod Automatic, the cleaning cycle will start first. You will need to wait up to 7 minutes before you see the normal filtration cycle starts to work.

We recommend that all electrical work on your EazyPod Automatic System be done by a suitably qualified electrician.

Ensure that the UV is switched off at the mains before you attempt to conduct any type of maintenance.

WARNING: PLEASE READ THE FOLLOWING SAFETY INFORMATION FIRST.

IMPORTANT SAFETY INFORMATION

- Please Read Carefully
- Never look directly at an illuminated UV bulb.
- Do not run this unit dry.
- Please ensure that the EazyPod Automatic is full of water before switching it on.
- Always isolate the unit from mains electricity and turn off any water supply before carrying out any maintenance.
- Always disconnect all pond appliances from the mains supply before putting your hands into the water.
- Use in the area of the garden pond only if the installation complies with the relevant wiring regulations.
- Power must be supplied through a Residual Current Device (RCD) with a residual operating current not exceeding 30mA.
- This unit must be earthed. Never use a fuse larger than 3 amps on the power lead.
- The unit must not be submerged in water.
- If the quartz sleeve is cracked, replace it immediately.
- The unit must be either fully frost protected or taken inside during Winter months.
- Young children should always be supervised near water.



PRODUCT INFORMATION

- **Rating:**
220-240V, 50Hz.
18 Watt UV
- Control box is IP68. Automatic Valve is IP64. UV unit is IP54.
All units are CE approved.
- UV Bulb Specification: 18 Watt PL-L UV-C Bulb

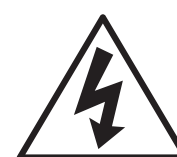
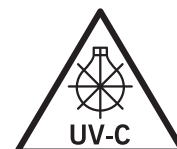

Disposal Of Your Old Product

Your product is designed and manufactured with high quality material and components, which can be recycled and reused. When this crossed-out wheeled bin symbol is attached to a product, it means the product is covered by the European Directive 2002/96/EC. Please contact your local authority about correct disposal for electrical and electronic equipment. Our WEE Registration Number is WEE/FE1471RR.

Please act according to your local rules and do not dispose of your old products with your normal household waste. The correct disposal of your old product will help prevent potential negative consequences for the environment and human health.



INTRODUCING THE EAZYPOD AUTOMATIC

Please read this instruction manual carefully from start to finish before attempting to install your EazyPod Automatic.



CONTENTS

Parts list	PAGE 04
Dimensions	PAGE 05
How the EazyPod Automatic Works	PAGE 06
Components	PAGE 07
Setting up the EazyPod Automatic	PAGE 08
Specification and flow rates	PAGE 10
Installation	PAGE 11
Connection to the electricity supply	PAGE 13
Cleaning with the EazyPod Automatic	PAGE 18
The cycle timer explained	PAGE 19
Setting the cycle timer	PAGE 20
Automatic cleaning operation	PAGE 22
Cleaning principles	PAGE 23
Cleaning the UV Quartz sleeve	PAGE 24
Replacing the UV bulb	PAGE 25
Troubleshooting	PAGE 26
Warranty	PAGE 27

EAZYPOD AUTOMATIC PARTS

Your EazyPod Automatic / EazyPod UV Automatic comes complete with the following items:



1" AUTOMATED WASTE VALVE
(Factory fitted to EazyPod)

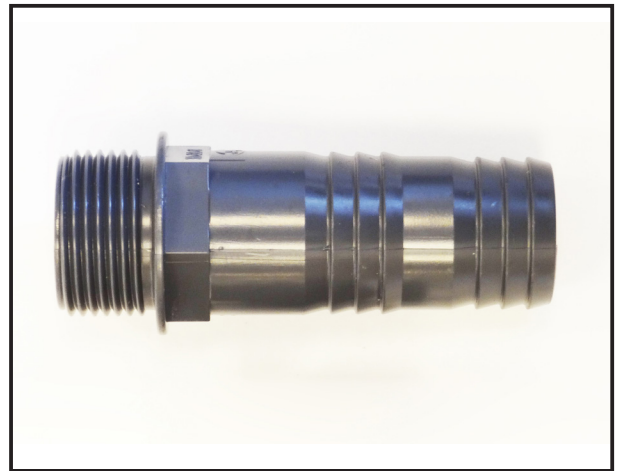

1" THREADED HOSETAIL FOR AUTOMATED WASTE VALVE



EAZYPOD LID



K1 MICRO FILTER MEDIA



4 TO 3 INCH EAZYCONNECTOR FOR OUTLET



HOSETAIL AND O-RING FOR INLET

DIMENSIONS

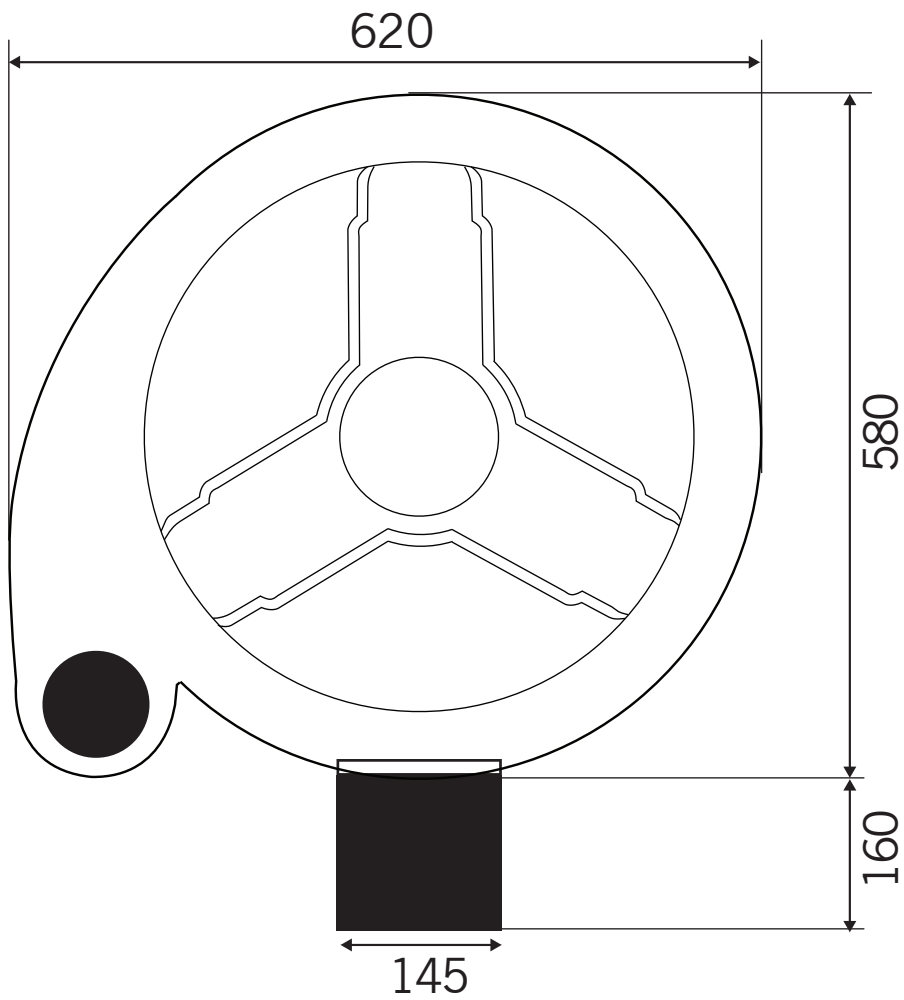
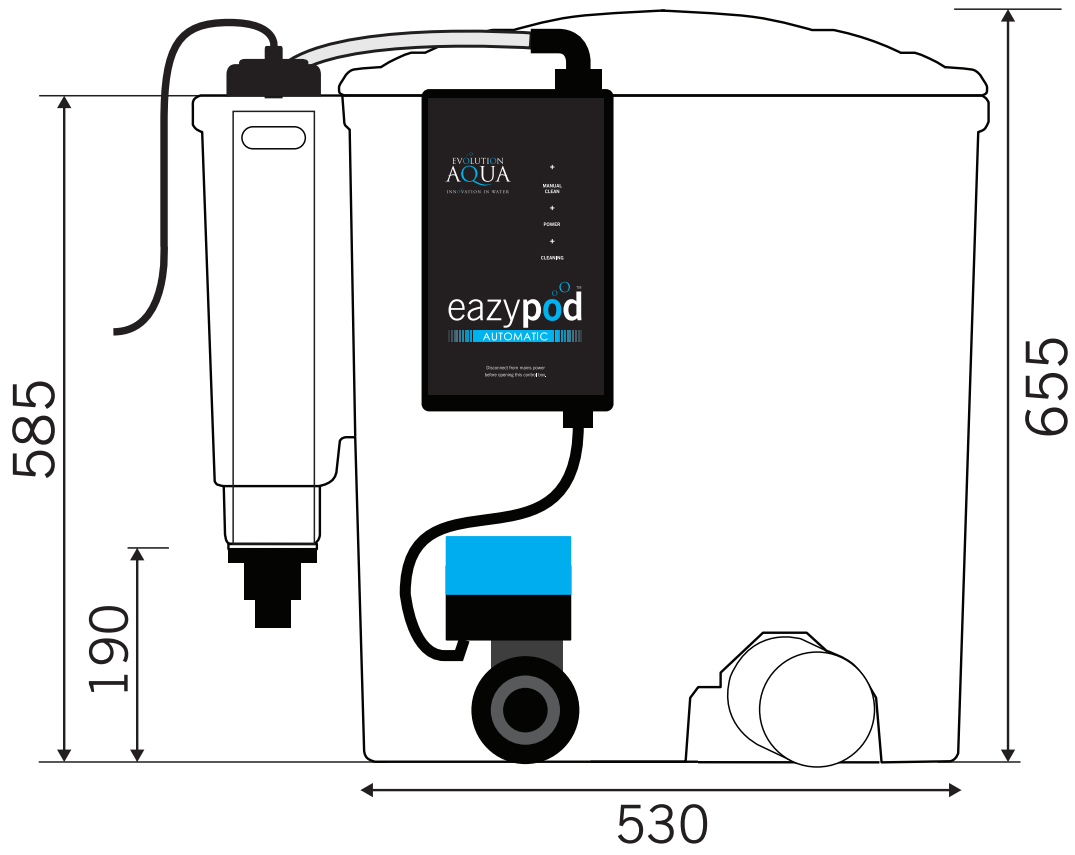

HOW THE EAZYPOD AUTOMATIC WORKS

The concept of the **EazyPod Automatic** is simple and yet innovative. Water enters via the inlet **(A)** and passes over an **18 watt UV** Clarifying bulb **(L)** (*on UV versions*), helping to kill any single celled algae in the water.

The water then enters the outer chamber **(B)**, which runs around the entire circumference of the EazyPod. Between the outer chamber **(B)** and the inner chamber **(C)**, is a stainless steel perforated screen **(H)**. These perforations are situated in the lower half of the screen and around its entire face. This means that when the water passes from the outer to inner chamber **(B to C)** a downward and upward flow is created. This causes many of the larger solids to settle in the base of the outer chamber **(B)**, due to the force of gravity.

The size of the perforations will not allow large mechanical waste to enter the inner chamber **(C)**, thus acting as a first stage mechanical filter. The inner chamber holds **18 litres** of static **K1 Micro media**. As the water enters the inner chamber, the fine smaller solids become entrapped in the K1 Micro. After passing through the K1 Micro, the clean water then rises and overflows into the inner return pipe **(E)**. From here it returns to the pond via the return outlet **(I)**.

The EazyPod Automatic filtration system gives water quality and clarity that surpasses all expectations. The nature and volume of the K1 Micro means, that when static, apart from being a very efficient mechanical filter, there is more than enough surface area for beneficial bacteria to colonise. Therefore on a smaller pond, the EazyPod Automatic is an excellent complete filter.

PLEASE NOTE that in normal running, the K1 Micro has to be static – it is only moved during cleaning and maintenance. If the K1 Micro is moved in normal operation, whether by air or by hand, all of the debris it has collected will be returned to the pond! The K1 Micro is cleaned by the integrated air pump located inside the control box, that is connected to the air line **(P)** in the EazyPod Automatic, which in turn goes to an air ring **(G)** in the base of the inner chamber **(C)**. The air ring has small holes in it which causes the K1 Micro to move and therefore clean itself.

During the cleaning cycle, the finer particles escape into chamber **(B)** from the K1 Micro. This waste water will be automatically dumped via a 1 inch motorised ball valve **(J)**.

Your EazyPod Automatic will help to keep your pond clear of green water. As with any filter that works in combination with a UV, the effectiveness of the UV light will depend on stocking levels, sunlight / shade, daily sunshine amounts etc.

Please check the table on page 10 to make sure you run your EazyPod Automatic within our specified limits to achieve the best results.

COMPONENTS

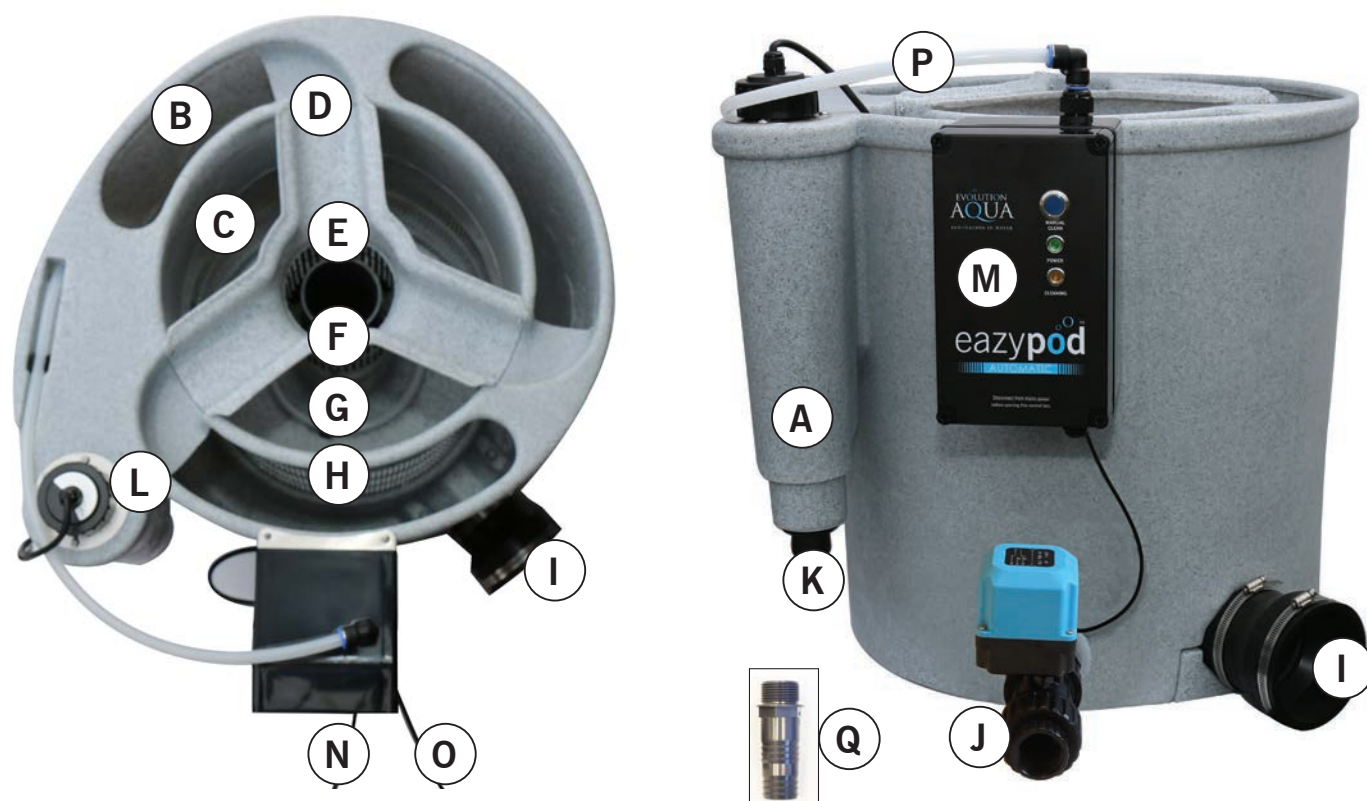

Description	Identity Letter
Inlet	A
Chamber B - Outer Chamber	B
Chamber C - Inner Chamber	C
Overflow Assembly	D
Return Pipe	E
Stainless Steel Perforated Pipe	F
Air Ring	G
Stainless Steel Perforated Screen	H
Outlet: 4"-3" EazyConnector	I
Automated Waste Valve	J
Inlet: 1½" Hosetail	K
UV Clarifier Bulb Unit (18 W PL-L Bulb) *	L
Automatic Control Box	M
Pump Power Cable (NOT SUPPLIED)	N
Mains Power Cable (NOT SUPPLIED)	O
Airline for cleaning	P
Threaded hosetail for waste valve	Q

*ON EAZYPOD UV AUTOMATIC MODELS

SETTING UP THE EAZYPOD AUTOMATIC

To set up your EazyPod Automatic ready for use, follow these simple steps:

ADD K1 MICRO

Your EazyPod Automatic is supplied with 18 litres of K1 Micro. Simply empty the entire bag into the inner chamber (C) of the EazyPod Automatic.



FIT THE INLET HOSETAIL



STEP 1: Fit O-Ring on the hosetail thread of the inlet hosetail.



STEP 2: Screw the hosetail into the inlet thread.



STEP 3: Ensure the hosetail is hand tightened until the rubber O-ring seals on the inlet face. (DO NOT OVERTIGHTEN)

SETTING UP THE EAZYPOD AUTOMATIC

FIT THE EAZY CONNECTOR ON THE OUTLET PIPE

Fit the 4"-3" EazyConnector onto the outlet pipe and tighten the jubilee clip with a flat head screwdriver.



CONNECT HOSETAIL / PIPE INTO AUTOMATIC WASTE VALVE

You can connect your waste valve to flexible hose (minimum 1") with the help of the threaded hosetail provided. To connect to 1" PVC pipe use Straight Connector 1" Threaded Male to Plain Female (EA Code: **K82-23-33**), available from Evolution Aqua and all EA stockists.

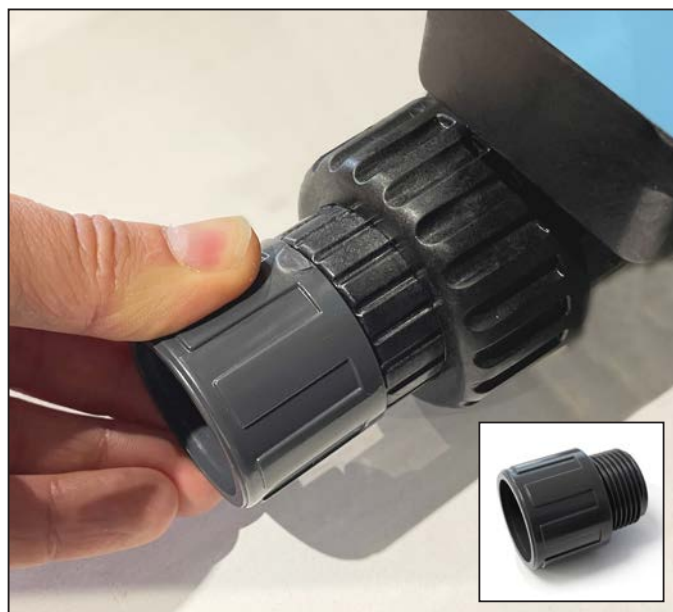

SPECIFICATION AND FLOW RATES

The EazyPod Automatic is truly multi-functional. It can be run in several different ways for different applications.

The EazyPod Automatic can be used:

- as a stand alone filter on a small pond
- as a complete filter on a quarantine system
- as a pre-filter at the front of any new or existing system
- as a polisher at the end of any system
- off a mid water feed to aid mechanical filtration
- on a skimmer line as a mechanical filter

Remember that if you use the EazyPod Automatic solely as a mechanical filter, you will also get an enhanced biological benefit in your system.

EazyPod Automatic Specifications and Flow Rates

Follow this manual carefully and your filter will provide a perfect environment for your fish. One of the factors that can have a significant influence on our ponds is the **turn over** rate. This is the time that it takes for the total water volume of the pond to pass through the filter system once. On ponds, where an EazyPod Automatic is used as the only filtration system, a total pond volume turn over of every 1 to 2 hours is required.

Therefore if you have a 10,000 litre pond, a minimum rate of 5,000 litres per hour is needed giving a 2 hour turnover, although you could also run at 10,000 litres per hour giving a turnover rate of once per hour.

Max flow rate:	10,000 litres/hr	2,200 UK gallons/hr	2,640 US gallons/hr
Max pond size for all fish	10,000 litres	2,200 UK gallons	2,666 US gallons
Max pond size with the addition of supplementary UV	20,000 litres	4,400 UK gallons	5,333 US gallons
K1 Micro	18 litres		
Max feed rate	100 - 120g per day		
AirPump	Factory fitted inside control box		
UV Bulb Specification	18 Watt PL-L UV-C		
UV Bulb Life	Recommended bulb change every 8000 hours		

INSTALLATION

PLEASE NOTE: EazyPod Automatic is designed to be used on a **PUMP FED SET-UP ONLY**. The EazyPod Automatic **MUST NOT** be installed as a Gravity Fed set-up.

The diagram below shows the EazyPod Automatic on a typical Pump Fed set-up. A Pump Fed set-up is when water is pumped from the pond to the filter.

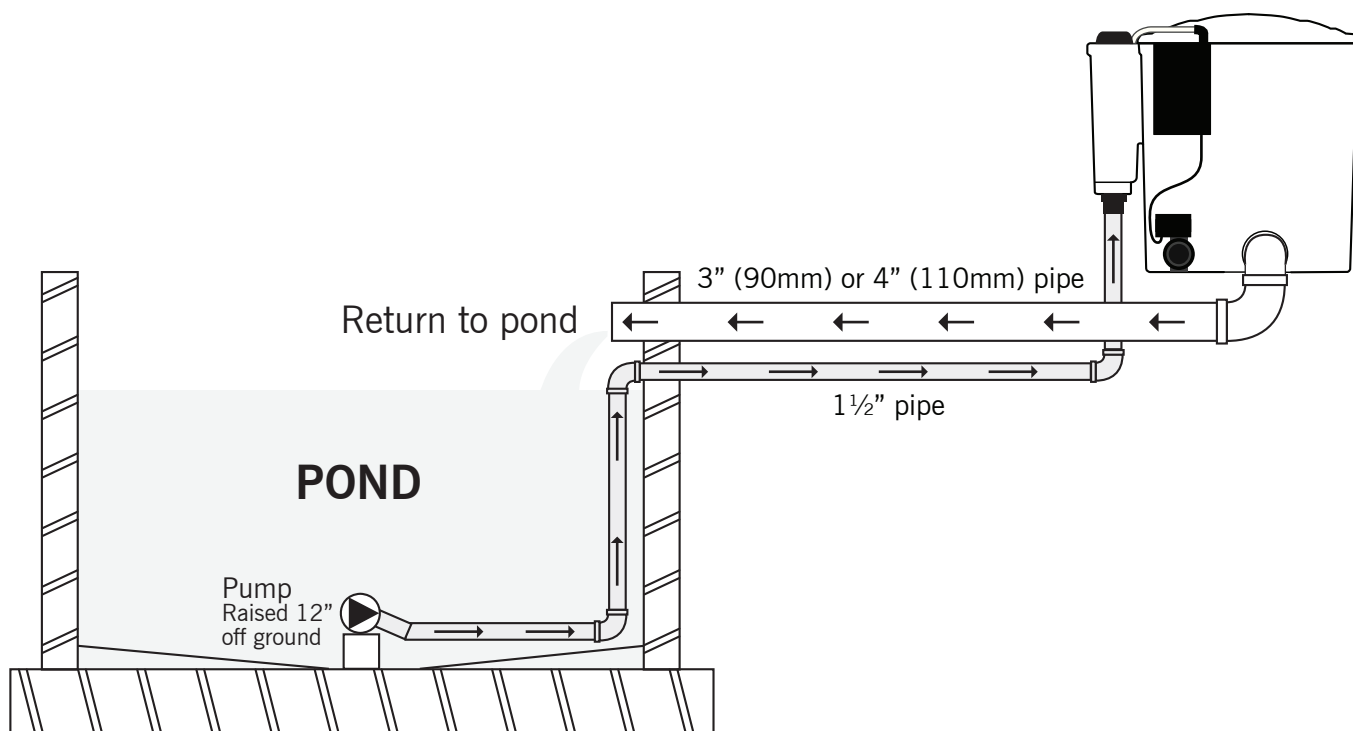

PLEASE NOTE: The pump must not be placed on the base of the pond, as failure in the pipe work or connectors could lead to complete drainage of the pond. The pump should be raised at least 12" off the ground or high enough to leave sufficient water for the fish to survive, in the unlikely event that this occurs.

IMPORTANT: A solid, level base is required for the EazyPod Automatic. It should be a minimum of 600mm x 600mm, to allow easy access to your valves and for maintenance purposes.

The EazyPod Automatic filter needs to be supported evenly on a level base (a paving flag is ideal). Failure to do so could cause damage when it is full of water.

INSTALLATION

INSTALLATION EQUIPMENT

1. **Pond Pump.** Please ensure that the pump's maximum actual flow rate is no more than the specified limits (see page 10).
2. **Pipe work** from the unit's waste valves to the intended discharge point. This can be rigid pipe work or a simple flexible hose of at least 1" diameter.
3. **Mains cable (3 core)** of an appropriate length to connect the EazyPod Automatic control box to your power socket.

The EazyPod Automatic comes ready to be installed on a **PUMP FED** set-up - no changes to any of the fittings are required.

The EazyPod Automatic should be situated at a height above the pond water level, to allow adequate gravity return to the pond (subject to the maximum performance of your chosen pump).

The gravity return pipe work from the exit point of the EazyPod Automatic to the pond needs to be a minimum of 3 inches (90mm), 4" (110m) for flow rates over 7,500 litres per hour and should have no restrictions. Great care should be taken to ensure that no air locks are created within the gravity return pipe work. The return pipe should have an "appropriate fall" from the EazyPod Automatic to the pond.

The pipe work from the pond pump to the inlet of the EazyPod Automatic will need to be connected to the 1.5 inch (50mm) inlet hoesetail (**K**). The 4 inch / 90-115 mm (minimum) gravity return pipe work will need to be connected to the rubber adaptor (**I**) on the outlet point of the EazyPod Automatic.

This fitting when first connected to this pipe could appear too big (especially 90mm) or too large 4" (115mm) – it will however reduce/stretch with the clip provided and make a tight seal – this is done with a screwdriver. The return pipe is then extended and returned to the pond or waterfall as required.

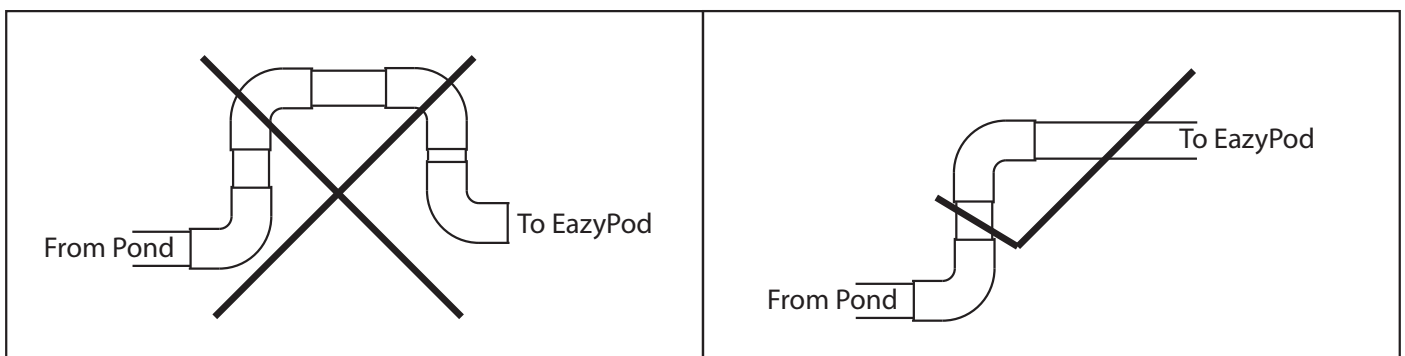

CONNECTION TO THE ELECTRICITY SUPPLY

PLEASE NOTE: Electrical installations must be done by a qualified electrician.

The power supply must meet the specifications on the product.
The cores in the supply cable are coloured in accordance with the following code:

Brown = Live. Blue = Neutral. Earth = Green/Yellow.

Do not use the cable to lift the EazyPod Automatic as this may cause damage.

WARNING - A Residual Current Device (RCD), also known as the Residual Current Circuit Breaker (RCCB), with a tripping current not exceeding 30mA must be installed in the supply circuit. A means of disconnection from the supply having a contact separation of at least 3mm in all poles must be incorporated in the wiring.

Caution: Use in the area of the garden pond only if the installation complies with the relevant wiring regulations. Please consult a qualified electrician.

Caution: Always disconnect all pond appliances from the mains supply before putting your hands into the water.

All electrical installations and wiring must be adequately protected to prevent any damage.

CONNECTING UV TO THE ELECTRICITY SUPPLY

FOLLOW THE ADVICE ABOVE.

Enough electrical cable is supplied with the UV to connect to the mains electric. This unit must be connected to permanent wiring. A switch with 3mm contact separation must be provided in the fixed wiring to provide disconnection from the electricity supply.



GUIDANCE FOR ELECTRICAL CONNECTIONS

We recommend that all electric work on your EazyPod Automatic be done by a suitably qualified electrician.

ALWAYS DISCONNECT FROM MAINS BEFORE OPENING THE FRONT OF THE BOX.
For the avoidance of doubt: GREEN/YELLOW = EARTH, BROWN = LIVE, BLUE = NEUTRAL



1. To open the box, use a flat head screwdriver to unscrew the four plastic screws on the box. (The plastic screws remain in the lid)

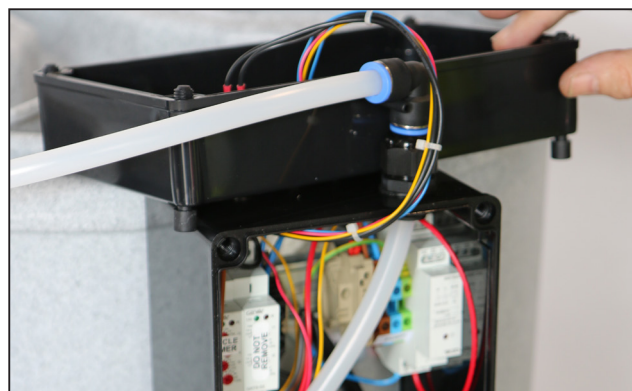

2. Carefully place the lid on top of the control box.

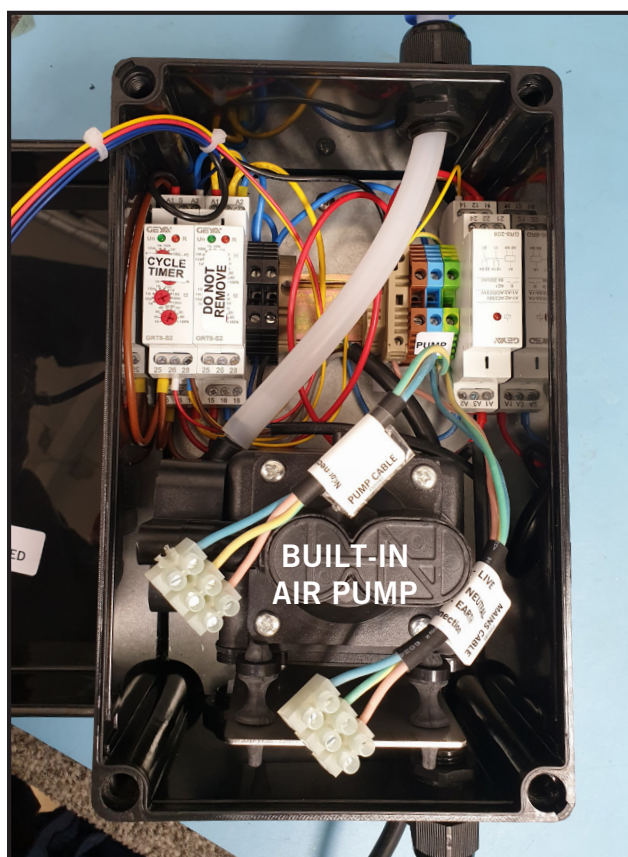

3. With the box front open, familiarise yourself with the connectors inside. The pump and mains cables are fitted with terminal blocks for easier connection to your pump and mains supply.

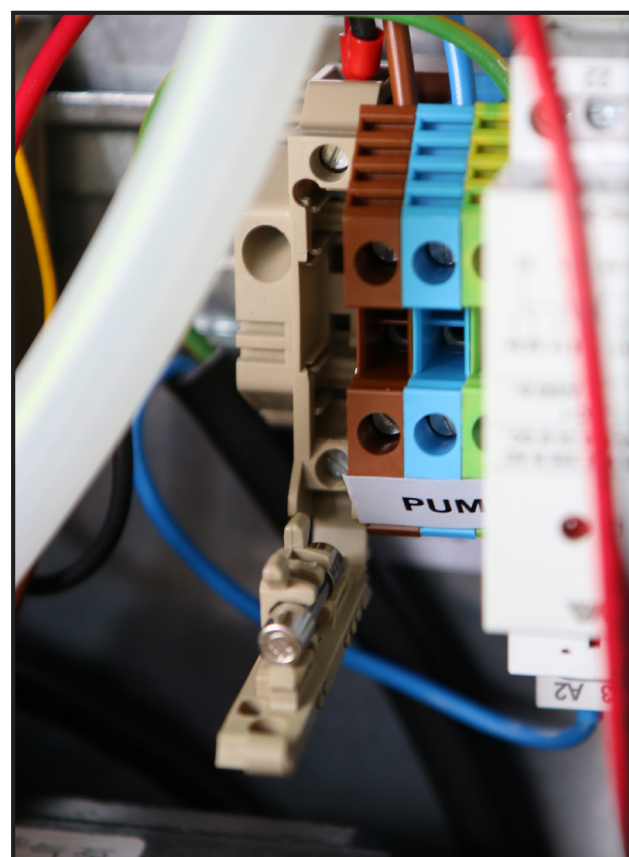

4. The fused connector block is hinged so it can be easily opened so that you have access to the 10 Amp fuse if you need to replace this.

GUIDANCE FOR MAINS POWER CONNECTION

We recommend that all electric work on your EazyPod Automatic be done by a suitably qualified electrician.

ALWAYS DISCONNECT FROM MAINS BEFORE OPENING THE FRONT OF THE BOX.

For the avoidance of doubt: GREEN/YELLOW = EARTH, BROWN = LIVE, BLUE = NEUTRAL

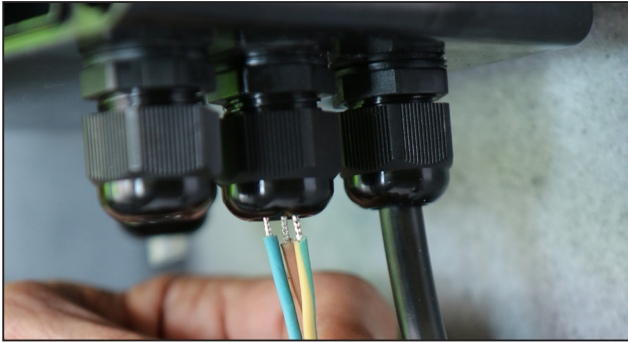

5. Ensure the 3 core mains cable you intend to use is long enough to reach the control box from your incoming mains supply. Feed this mains wire through the second gland nut on the base of the control box.

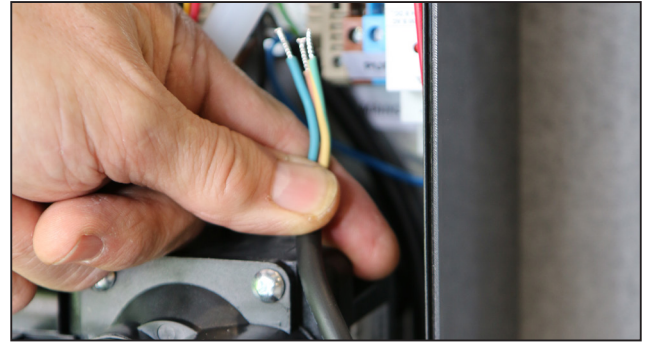

6. Feed enough wire into the control box to allow you to make the connections to the MAINS terminal block.

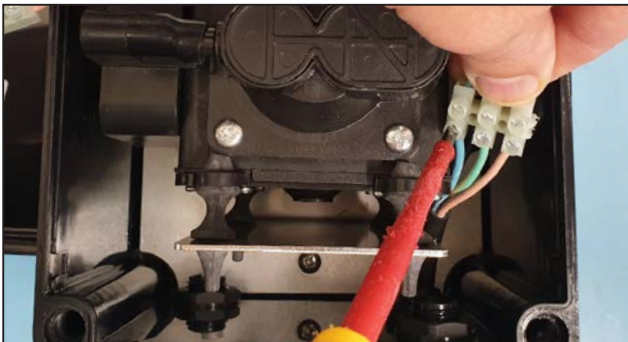

7. Fit the corresponding LIVE, EARTH and NEUTRAL wires into the matching terminal labelled MAINS and tighten with a screwdriver.



8. Now all three wires are connected up, tighten up the gland nut to hold the mains cable in position.

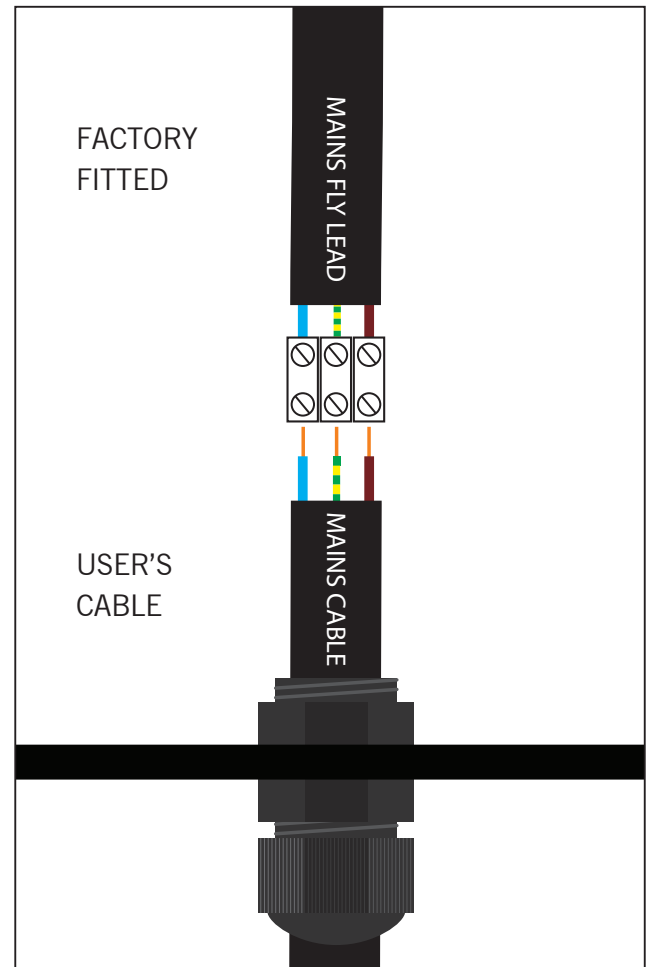

ENSURE ALL GLAND NUTS ARE TIGHTENED TO PREVENT WATER INGRESS.

GUIDANCE FOR CIRCULATING PUMP POWER CONNECTIONS

We recommend that all electric work on your EazyPod Automatic be done by a suitably qualified electrician.

ALWAYS DISCONNECT FROM MAINS BEFORE OPENING THE FRONT OF THE BOX.

For the avoidance of doubt: GREEN/YELLOW = EARTH, BROWN = LIVE, BLUE = NEUTRAL

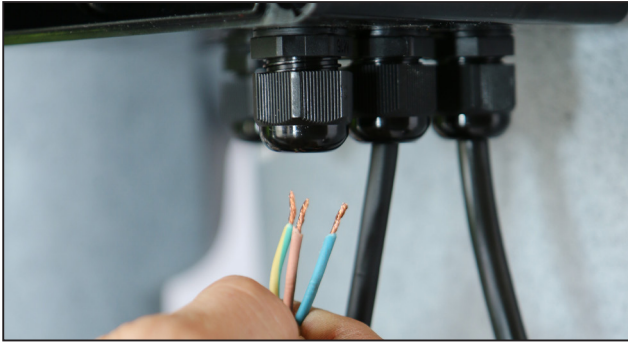

1. Take the 3 core cable from your circulating pump and feed this through the first gland nut on the base of the control box.

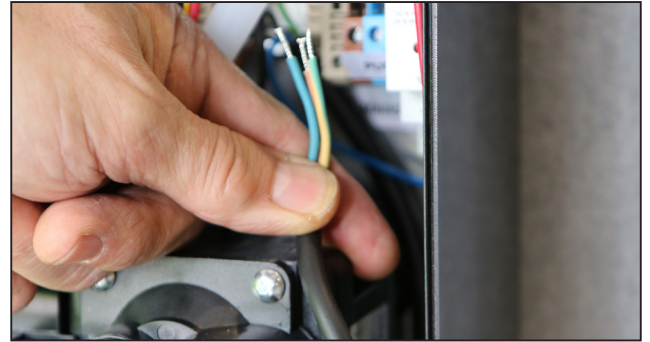

2. Feed enough wire into the control box to allow you to make the connections to the PUMP terminal block.

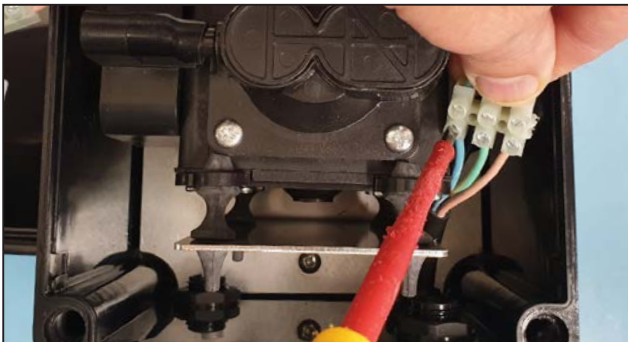

3. Fit the corresponding LIVE, EARTH and NEUTRAL wires into the matching terminal and tighten with a screwdriver.



4. Double check that the mains and pump wires are connected and there are no loose wires. Then tighten the gland nut up to hold the pump cable in position.

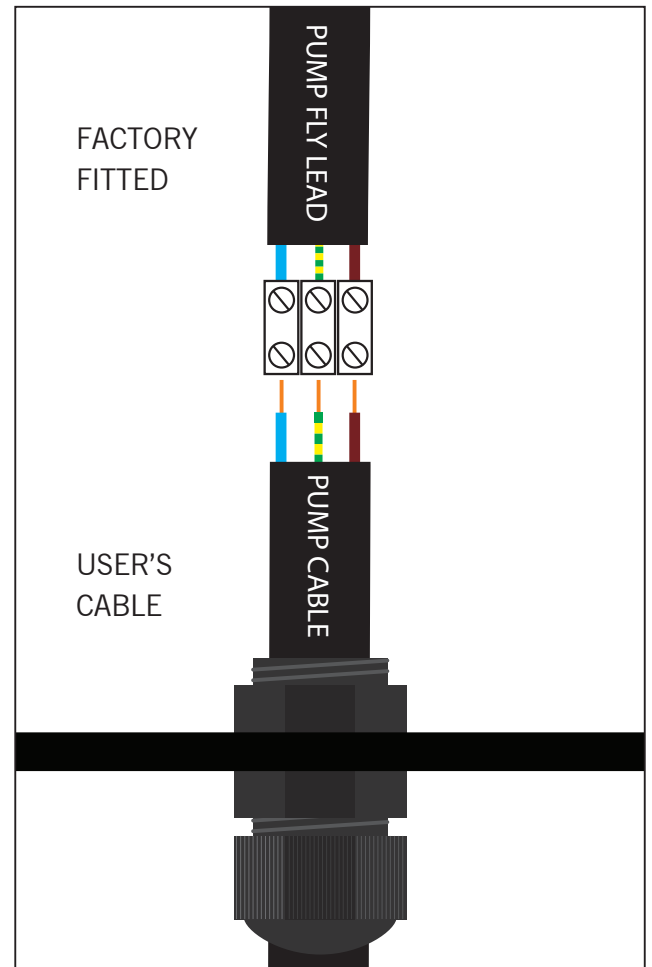

ENSURE ALL GLAND NUTS ARE TIGHTENED TO PREVENT WATER INGRESS.

GUIDANCE FOR ELECTRICAL CONNECTIONS

We recommend that all electric work on your EazyPod Automatic be done by a suitably qualified electrician.

ALWAYS DISCONNECT FROM MAINS BEFORE OPENING THE FRONT OF THE BOX.
For the avoidance of doubt: GREEN/YELLOW = EARTH, BROWN = LIVE, BLUE = NEUTRAL

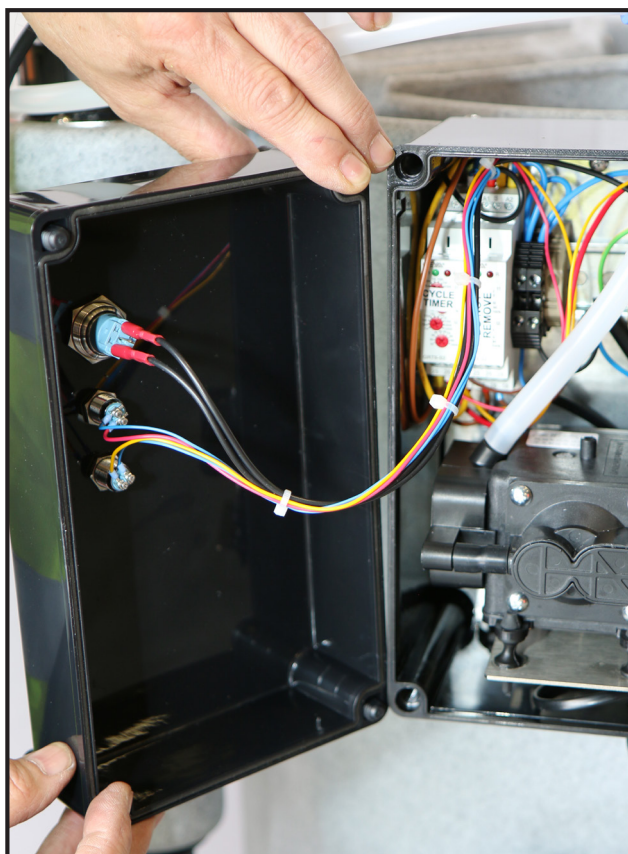

7. Carefully place the lid back in position to re-fit it.

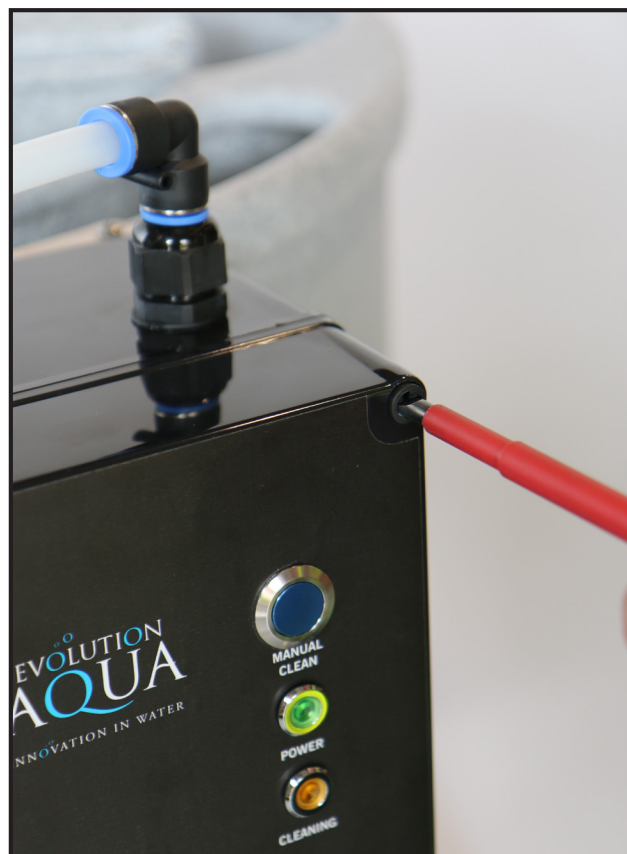

8. Use a flat head screwdriver to tighten up the four plastic screws into the box. **DO NOT OVERTIGHTEN.**



DO NOT UNSCREW OR TAMPER WITH ANY FACTORY FITTED WIRES.

CLEANING WITH THE EAZYPOD AUTOMATIC

PLEASE NOTE: When you first power up the EazyPod Automatic, a cleaning cycle will commence.

MANUAL CLEAN

When you push the “MANUAL CLEAN” button a cleaning cycle will begin.

Once initiated, we advise that you allow the cleaning cycle to run from start to finish. However, in unexpected circumstances by interrupting and restarting the power supply, the system will reset itself to a zero start condition for all functions (a power cut will have the same effect).

AUTOMATIC CLEAN

You do not need to push any buttons to start an Automatic Clean.

The frequency of cleaning is factory set to cycle once every three days.

This time period can be easily adjusted by changing the CYCLE TIMER located inside the control box.

Once an Automatic Clean is initiated, we advise that you allow the cleaning cycle to run from start to finish. However, in unexpected circumstances by interrupting and restarting the power supply, the system will reset itself to a zero start condition for all functions (a power cut will have the same effect).

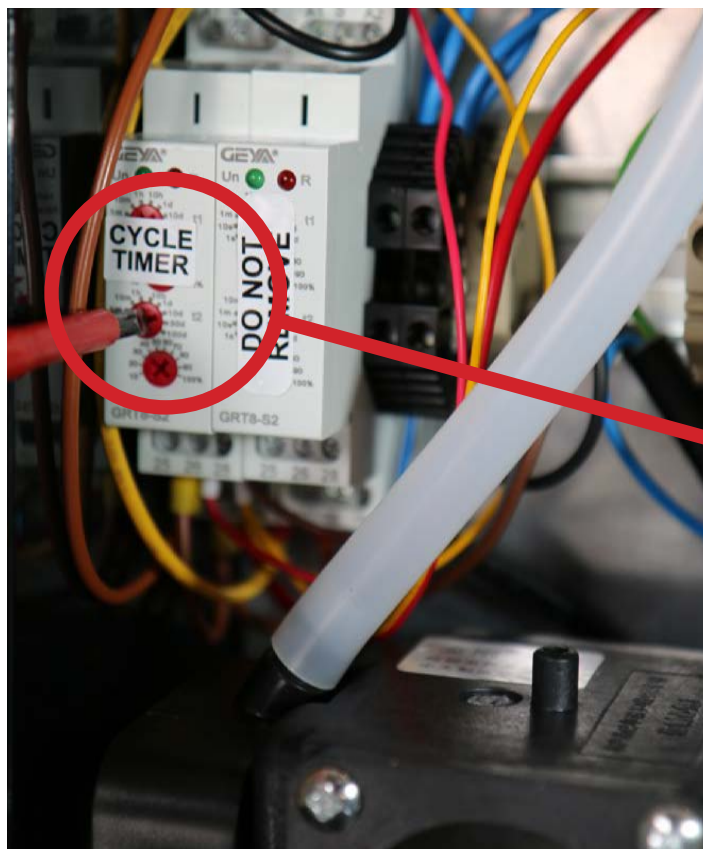

INSIDE THE CONTROL BOX

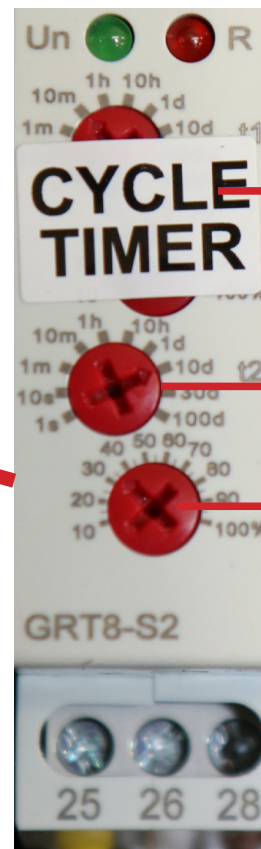

THE CYCLE TIMER

NEW

DO NOT ADJUST
(Covered by label)

SCREW A

SCREW B

THE CYCLE TIMER EXPLAINED

THE CYCLE TIMER EXPLAINED

**ONLY ADJUST SCREW A AND B ON THE CYCLE TIMER.
NEVER ADJUST ANY OTHER TIMER SCREW.**



THE CYCLE TIMER IS FACTORY SET TO INITIATE A CLEANING CYCLE ONCE EVERY 3 DAYS

This cleaning cycle is programmed by turning the bottom 2 red screws on the cycle timer block. Each screw head has an arrow which should point towards the correct digit you require.

SCREW A - This screw sets the number of times the cycle can be initiated in any period from one day through to 10 days on a coarse scale.

NEVER SET SCREW A AT LESS THAN 1 h

SCREW B - This screw sets a fine division within the coarse scale.

EXAMPLE - To enable the EazyPod Automatic to clean your EazyPod once every 3 days SCREW A points to 10 d (a coarse period of 10 days) and SCREW B points to 30 (30%). This instructs the timer to carry out 1 clean every 3 days.

KEY TO SYMBOLS ON THE CYCLE TIMER DISPLAY

DIGIT DISPLAYED ON TIMER	DESCRIPTION	USAGE
1 s	1 second	DO NOT USE
10 s	10 seconds	DO NOT USE
1 m	1 minute	DO NOT USE
10 m	10 minutes	DO NOT USE
1h	1 hour	DO NOT USE
10 h	10 hours	DO NOT USE
1 d	1 day	Can be used
10 d	10 days	Can be used
30 d	30 days	Can be used
100 d	100 days	DO NOT USE

SETTING THE CYCLE TIMER

If you do not want to have your EazyPod cleaned once every 3 days, as is factory set, you can alter the cleaning frequency to suit your needs. Simply turn **SCREW A** and **SCREW B** to point to the different digits using the sequences shown in the tables below:

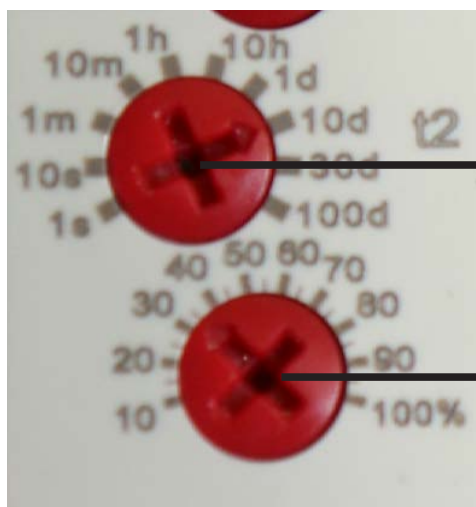

Use a pozi-drive screwdriver to turn the screw head, so the arrow on the dial points to the appropriate digit.

SCREW A - This screw sets the time of the cycle. (Factory set pointing to 10 d)

SCREW B - This screw sets the frequency as a percentage of the time set above. (Factory set pointing to 30%)

SETTING THE CYCLE TIMER

TO HAVE YOUR EAZYPOD CLEANED MORE THAN ONCE PER DAY

USER'S CLEANING FREQUENCY	SCREW A POINTS TO	SCREW B POINTS TO
1 clean every day / 24 hours	1 d	100%
2 cleans every day / 24 hours	1 d	50%
3 cleans every day / 24 hours	1 d	30%
4 cleans every day / 24 hours	1 d	25%

TO HAVE YOUR EAZYPOD CLEANED BY DAY

USER'S CLEANING FREQUENCY	SCREW A POINTS TO	SCREW B POINTS TO
1 clean every 2 days	10 d	20%
** 1 clean every 3 days **	10 d	30%
1 clean every 4 days	10 d	40%
1 clean every 5 days	10 d	50%
1 clean every 6 days	10 d	60%

****FACTORY DEFAULT SETTING****

TO HAVE YOUR EAZYPOD CLEANED BY WEEK

USER'S CLEANING FREQUENCY	SCREW A POINTS TO	SCREW B POINTS TO
1 clean every 7 days	10 d	70%

AUTOMATIC CLEANING OPERATION

The EazyPod Automatic will control the cleaning cycle fully automatically. During the cleaning cycle, water is flushed to waste, this will mean that unless the water in your pond is topped up, the water level will go down.

We recommend that an automatic top up system or a constant trickle feed be added to your installation to allow for this. We strongly recommend using an Evolution Aqua Detox Dechlorinator which will remove harmful chlorine from your tap water. This ensures your pond is always topped up even when you are on holiday.



Cleaning is done on a timer, which is factory set at every 3 days, however, this is easily adjustable to fit in with your pond requirements. (See “SETTING THE TIMER on page 21”)

The EazyPod Automatic will run a cleaning cycle which lasts approximately 6 and a half minutes.

EazyPod Automatic cleaning cycle:

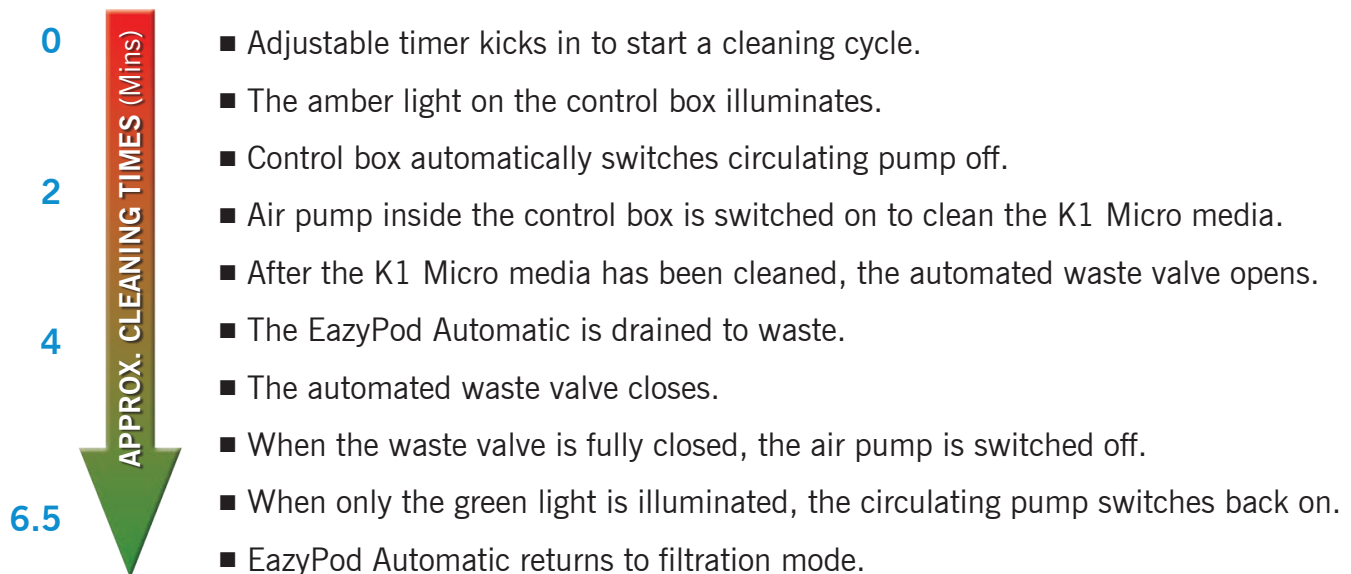

*NOTE: If the circulation pump does not switch on, then the waste valve is not fully closed and you will see both the green and amber lights illuminated. This safety feature is built in to ensure that you cannot empty your pond.

CLEANING PRINCIPLES

The generally accepted practice is that when you keep ornamental fish, whether in a pond or in an aquarium, to keep the water fresh, 10% of the volume of the water in the pond/aquarium should be changed on a weekly basis.

With this in mind, we recommend that you set your EazyPod Automatic to run a cleaning cycle so as to exchange water in line with this.

FOR EXAMPLE – the EazyPod Automatic cleaning cycle will send around 80 litres of water to waste. If your pond is 1600 litres, then it would need approx. 2 cleaning cycles per week to do a 10% water change, so the EazyPod Automatic should be set up to clean on once every 3 days.

To alter the timer, see “SETTING THE TIMER on page 21”.

The EazyPod Automatic can also run a cleaning cycle on demand, simply by pressing the “Manual Clean” button.

NOTE: In the Summer when you feed more frequently, the fish generate more waste and if you see that water by-passes through the overflow then we would recommend to increase the cleaning frequency.



Waste valve may differ from one shown

CLEANING THE UV QUARTZ GLASS

ALWAYS ISOLATE THE UNIT FROM ANY ELECTRICITY AND WATER SUPPLIES BEFORE CARRYING OUT MAINTENANCE ON THE UNIT.

If you notice an increase in algae formation and/or see that limescale is forming, you will need to check that the UV bulb is working properly. To ensure peak efficiency, the UV bulb must be replaced every 8000 hours of operation.

How to Clean the UV Quartz glass:

1. Unplug the UV light's power plug.
2. Switch off the water pump.
3. Unscrew the black cable grommet and UV retaining collar and carefully pull out the device head along with the UV bulb (**please do not touch the UV bulb**) (FIG. 16.1 - 16.3)
4. To remove the quartz sleeve carefully ease out from inside the unit. This may be tight. (FIG. 16.4)
5. Now you can clean the quartz sleeve with a damp cloth.
6. Check the quartz sleeve for damage before putting it back.
7. Put the Quartz glass back in the unit and be sure that the orange O-ring is in place and is clean.
8. Check that the black O-ring is in the groove of the quartz sleeve. (FIG. 16.5)
9. Put the device head back in the Quartz sleeve and screw it tight. (FIG. 16.7)
10. Tighten the cable grommet to secure the cable. (FIG. 16.8)
11. Switch on the water pump and check for any leaks.
12. Now you can switch on the UV.



FIGURE 16.1



FIGURE 16.2



FIGURE 16.3



FIGURE 16.4



FIGURE 16.5



FIGURE 16.6



FIGURE 16.7



FIGURE 16.8

As already mentioned, it is essential that the unit is protected from frost during the winter months, or disconnected from water and electricity supplies and stored indoors. During the spring and summer season, the quartz sleeve, which separates the UV bulb from the water passing through the unit, will need to be cleaned two or three times. This is essential, as dirt or limescale building up on the quartz sleeve will inhibit the penetration of the ultraviolet light into the water and affect the efficient working of the unit.

CLEANING THE UV QUARTZ GLASS

ALWAYS ISOLATE THE UNIT FROM ANY ELECTRICITY AND WATER SUPPLIES BEFORE CARRYING OUT MAINTENANCE ON THE UNIT.

If you notice an increase in algae formation and/or see that limescale is forming, you will need to check that the UV bulb is working properly. To ensure peak efficiency, the UV bulb must be replaced every 8000 hours of operation.

How to Replace the UV Bulb: (You will to purchase a replacement 18 Watt PL-L UV Bulb)

1. Unplug the UV light's power plug.
2. Switch off the water pump.
3. Unscrew the black cable grommet and UV retaining collar and carefully pull out the device head along with the UV bulb (**please do not touch the UV bulb**) (FIG. 17.1 - 17.3)
4. When removing the UV bulb it is better to use a dry cloth to hold the UV bulb.
5. Now you can clean the quartz sleeve with a damp cloth.
6. When replacing the tube, please remove the bulb transit clip (if present). (FIG. 17.4)
7. Now you can remove the 18 Watt PL-L UV bulb. (FIG. 17.5)
8. Put a new 18 W PL-L UV bulb in the four pin socket. You do not need to replace the transit clip as it is no longer needed. (FIG. 17.6)
9. Check that the black O-ring is in the groove of the quartz sleeve.
10. Put the device head back in the Quartz sleeve and screw it tight. (FIG. 17.7)
11. Tighten the cable grommet to secure the cable. (FIG. 17.8)
12. Switch on the water pump and check for any leaks.
13. Now you can switch on the UV.



FIGURE 17.1



FIGURE 17.2



FIGURE 17.3



FIGURE 17.4



FIGURE 17.5



FIGURE 17.6



FIGURE 17.7



FIGURE 17.8

As already mentioned, it is essential that the unit is protected from frost during the winter months, or disconnected from water and electricity supplies and stored indoors. During the spring and summer season, the quartz sleeve, which separates the UV bulb from the water passing through the unit, will need to be cleaned two or three times. This is essential, as dirt or limescale building up on the quartz sleeve will inhibit the penetration of the ultraviolet light into the water and affect the efficient working of the unit.

TROUBLESHOOTING

There is no power to the control box

- Check the wiring is correctly installed. Seek advice from a suitably qualified electrician if in doubt.
- Check the mains connection to the control box. Seek advice from a suitably qualified electrician if in doubt.
- Check the fuse inside the control box. This is located in the hinged compartment on the left hand side of the pump connector block. The fuse is a standard 10 Amp glass fuse.
- Please be aware that every control box system is fully factory tested.

EazyPod Automatic does not drain to waste

- Check that the 1" ball valve on the EazyPod Automatic is in an open position. (You can check this by removing the union end from the waste valve)
- Is cleaning cycle fully operational. From initiating a cleaning cycle it will take 3 to 4 minutes before the automated waste valve opens.
- Check automated waste valve is connected correctly. Please be aware that every waste valve is fully factory tested.

EazyPod Automatic does not close waste valve

- You will find out that the circulation pump will not switch on and the green and amber light are both illuminated.
- Remove the unions from the waste valve and check for any blockages.
- Check the fuse inside the control box. This is located in the hinged compartment on the left hand side of the pump connector block. The fuse is a standard 10 Amp glass fuse.
- If this does not solve the problem, contact your Evolution Aqua dealer.

Problems with blanketweed

- If a blanketweed treatment is used, clean the inside of the EazyPod with a hose pipe after use.

FURTHER ADVICE

Should the EazyPod Automatic not function as set out in this manual, more fault finding information can be found on our website:

www.evolutionaqua.com

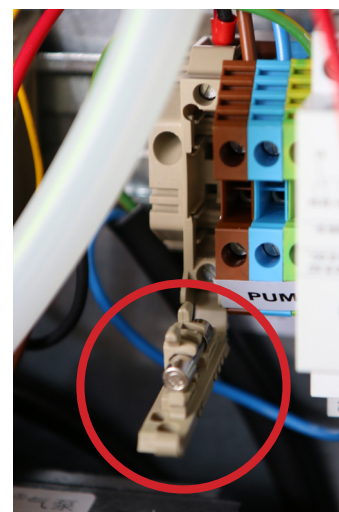

LOCATION OF FUSES

WARRANTY

This product is guaranteed against defects in material and workmanship for 1 year from the date of purchase, under normal usage. The guarantee DOES NOT APPLY in case of improper use, negligence, lack of maintenance or accidental damage to the EazyPod Automatic. If the EazyPod Automatic fails due to a manufacturing fault within this period it will be either repaired or replaced free of charge. Liability is limited to replacement of the faulty product only; no other costs will be reimbursed. This guarantee is not transferable and does not affect your statutory rights. This guarantee does not confer any rights other than those expressly set out above.

Do not attempt to tamper with the EazyPod Automatic components, other than as directed in this instruction manual, as doing so will invalidate the warranty.

The manufacturer or supplier shall not be responsible, or held liable for any damages caused by defective components or materials of this product; or for loss incurred by interruption of service; or any consequential/incidental damages and expenses arising from the production, sale use or misuse of this product or any other consequential loss; or for damage as a result of cold weather or extreme weather related conditions.

Any warranty claim must be accompanied by a valid, dated proof of purchase.

Evolution Aqua and its dealers shall not be held liable for any loss of fish, plants or any other livestock as a result of any failure or defect of this product.

The installation and use of your product outside of our recommendations as printed in this manual may also void the warranty.

Should the EazyPod Automatic not function as set out in this manual, more fault finding information can be found on our website:

www.evolutionaqua.com

Evolution Aqua Ltd

Evolution House
Kellet Close
Wigan
Lancashire
United Kingdom
WN5 0LP

t: +44 (0) 1942 216554
f: +44 (0) 1942 418489
e: info@evolutionaqua.com
w: www.evolutionaqua.com

EVOLUTION
AQUA
INNOVATION IN WATER



WARRANTY PROVISIONS

This product is guaranteed against defects in material and workmanship for 1 year from the date of purchase, under normal usage. The guarantee DOES NOT APPLY in case of improper use, negligence, lack of maintenance or accidental damage to the EazyPod Automatic System. If the EazyPod Automatic fails due to a manufacturing fault within this period it will be either repaired or replaced free of charge. Liability is limited to replacement of the faulty product only; no other costs will be reimbursed. This guarantee is not transferable and does not affect your statutory rights. This guarantee does not confer any rights other than those expressly set out above.

Do not attempt to tamper with the EazyPod Automatic components, other than as directed in this instruction manual, as doing so will invalidate the warranty.

The manufacturer or supplier shall not be responsible, or held liable for any damages caused by defective components or materials of this product; or for loss incurred by interruption of service; or any consequential/incidental damages and expenses arising from the production, sale use or misuse of this product or any other consequential loss; or for damage as a result of cold weather or extreme weather related conditions.

Any warranty claim must be accompanied by a valid, dated proof of purchase.

Evolution Aqua and its dealers shall not be held liable for any loss of fish, plants or any other livestock as a result of any failure or defect of this product.

The installation and use of your product outside of our recommendations as printed in this manual may also void the warranty.

Should the EazyPod Automatic not function as set out in this manual, more fault finding information can be found on our website: www.evolutionaqua.com

WARRANTY CARD

Or register online at
www.evolutionaqua.com



Your Name: _____

Customer Address: _____

Postcode: _____

Country: _____

Tel: _____

Mobile: _____

Email _____

Purchased From: _____

Address: _____

Postcode: _____

Country: _____

Tel: _____

Web: _____

Date of Purchase: / / _____

Model: _____

Serial Number: _____

I have read and accept the terms and conditions listed in the warranty card, and understand the obligations of the Customer under this warranty.

Signature: _____ Date: / / _____

Returning this registration form will amount to your consent for us to disclose your details and other personal information to other companies within the Evolution Aqua group including any subsidiary company or subcontractor of Evolution Aqua for the purposes of performing our obligations under the warranty. Evolution Aqua Ltd. may contact you in the future with product updates or offers, which may be of interest to you. If you do not wish to receive this information please tick this box.

TEL: 01942 216554 FAX: 01942 418 489

WARRANTIES - EVOLUTION AQUA - KELLET CLOSE - WIGAN - LANCASHIRE - WN5 0LP - TEL: 01942 216554



EVOLUTION
AQUA
INNOVATION IN WATER

eazypod™
AUTOMATIC

Evolution Aqua Ltd

Evolution House
Kellet Close
Wigan
Lancashire
United Kingdom
WN5 0LP

t: +44 (0) 1942 216554
f: +44 (0) 1942 418489
e: info@evolutionaqua.com
w: www.evolutionaqua.com